

Bridge Street Bridge

RECEIVED JUN 11 2018

Beacon, New York



A Historical Review, Existing Condition Report and Recommendations for Rehabilitation.

June 2018

**Dr. Francis E. Griggs, Jr., Dist. M. ASCE
Consulting Engineer
Specializing in Historic Bridge Preservation
30 Bradt Road
Rexford, NY 12148**

Table of Contents

Introduction-----	2
Squire Whipple and the evolution of the bridge design-----	4
Photographic documentation/description of bridge and its connections, members, etc. -----	13
NYSDOT previous inspections and 1977 Engineers Report-----	38
Structural analysis-----	41
Dan DeGennaro, PE Report-----	44
Structural evaluation, recommendations and tentative cost estimates-----	47
Conclusion-----	53

Introduction

The Bridge Street Bridge, located in Beacon, New York, crosses the Fishkill Creek, a tributary of the Hudson River, connecting Liberty Street with Front Street. It was built by the New York Bridge Company in 1879 for Charles M. Wolcott, who owned the adjacent Groveville Carpet Mill, as a means of mill worker access across the creek.

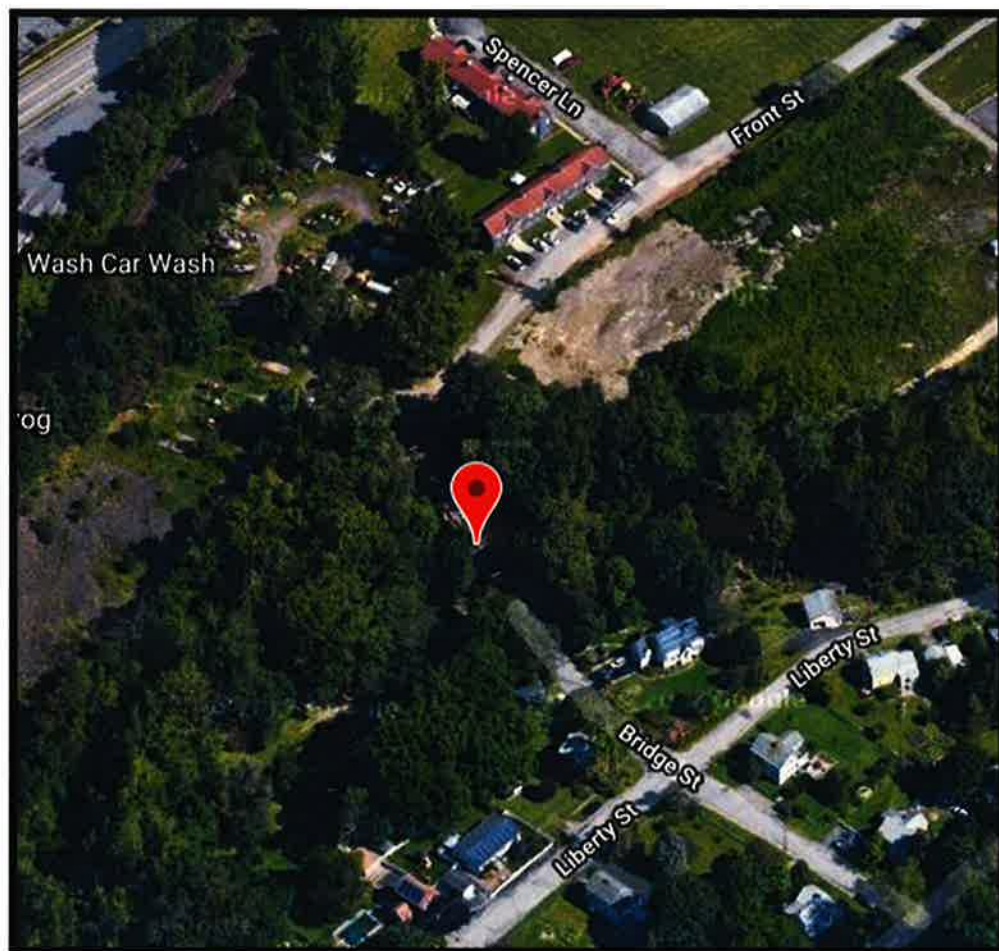

It is a Whipple double intersection wrought iron truss developed by Squire Whipple, the Father of the Iron Bridge Truss, in the 1840s. His original design utilized cast iron for all compression members and wrought iron for all tension members. The design was modified in the 1850s to an all wrought iron bridge by John W. Murphy who built several bridges of the type across the Delaware River near Easton, Pennsylvania. After the Civil War it was adopted by many railroads and bridge building companies as their standard design, first in iron and later steel.

One of the partners in the New York Bridge was James M. Shipman, a nephew of Squire Whipple. The other, John D. Hutchinson, was the son of John Hutchinson who built many Whipple bowstring bridges across the Erie Canal in the 1850s and 1860s.

It is the oldest bridge of its type in New York State. While a few years younger than the Tioronda Bridge, formerly located just downstream, it is of far greater historical significance given its link to Squire Whipple and the fact that the bridge style was the predominant style for railroad bridges built between the 1850s and 1890s gradually evolving from cast and wrought iron to all wrought iron and eventually steel. The longest span, in steel, built to the design was the Cairo Bridge in 1889 by George S. Morison across the Ohio River with the two longest spans being 518' in length.

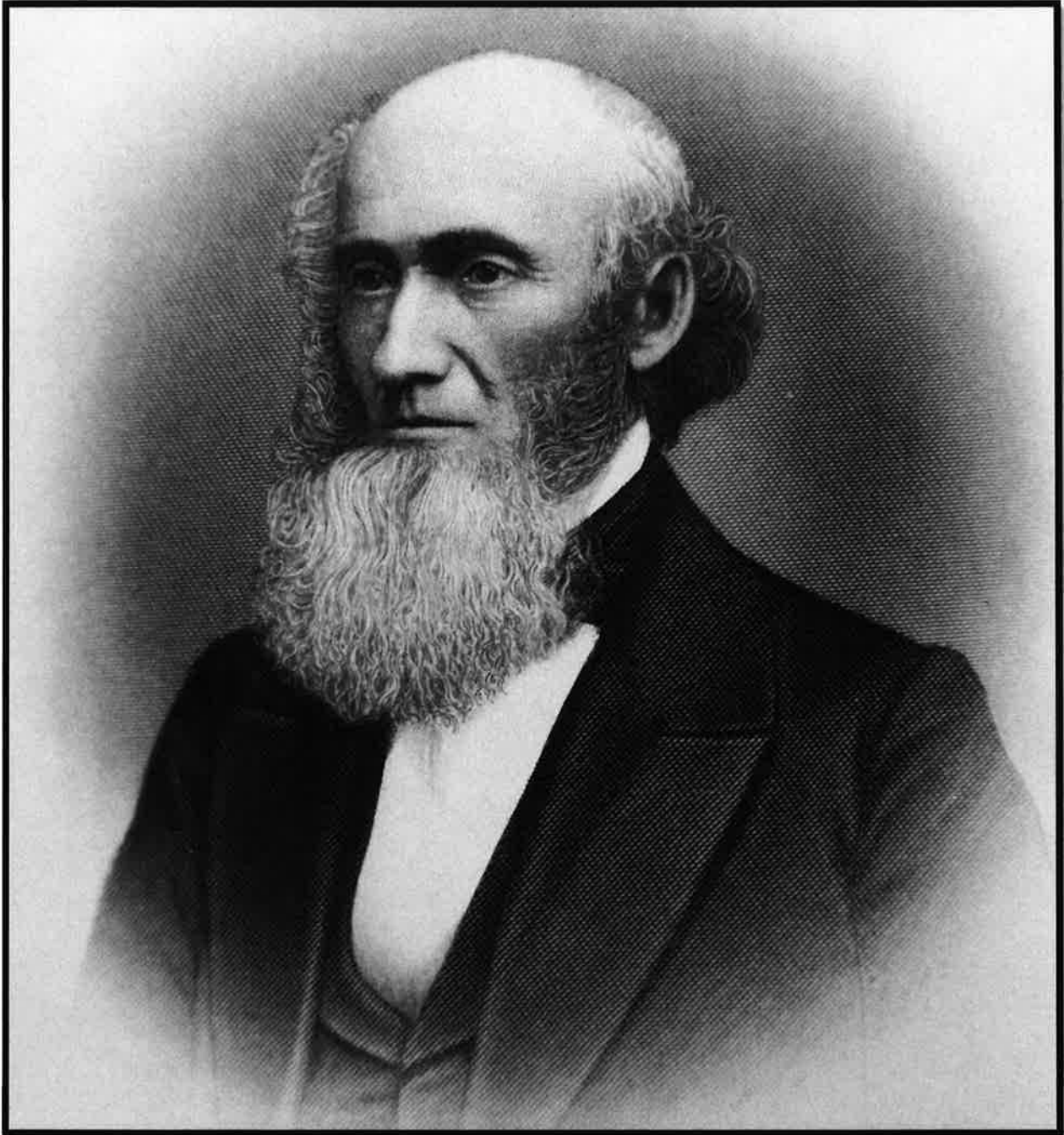

Squire Whipple 1804-1888 -- The Father of the iron truss bridge.

Squire Whipple and the evolution of the bridge design

The Bridge Street Bridge is a pin connected Whipple Double Intersection Truss that Squire Whipple first described in his 1847 book on Bridge Building. He first built a bridge on this plan across the Enlarged Erie Canal for the Rensselaer & Saratoga Railroad. To appreciate the design a brief summary of how Whipple arrived at it is of interest. Whipple was working on the enlargement of the Erie Canal in 1840 and, like many, knew that wooden bridges had limited life due to natural decay of wood in exposed weather environments. He determined that a bridge made of iron may cost more initially but would last longer than a wooden structure and its life cycle cost would be lower. He designed and built his first cast and wrought iron bowstring bridge across the Canal in Utica on First Street in 1840 and received a patent on the design in 1841.

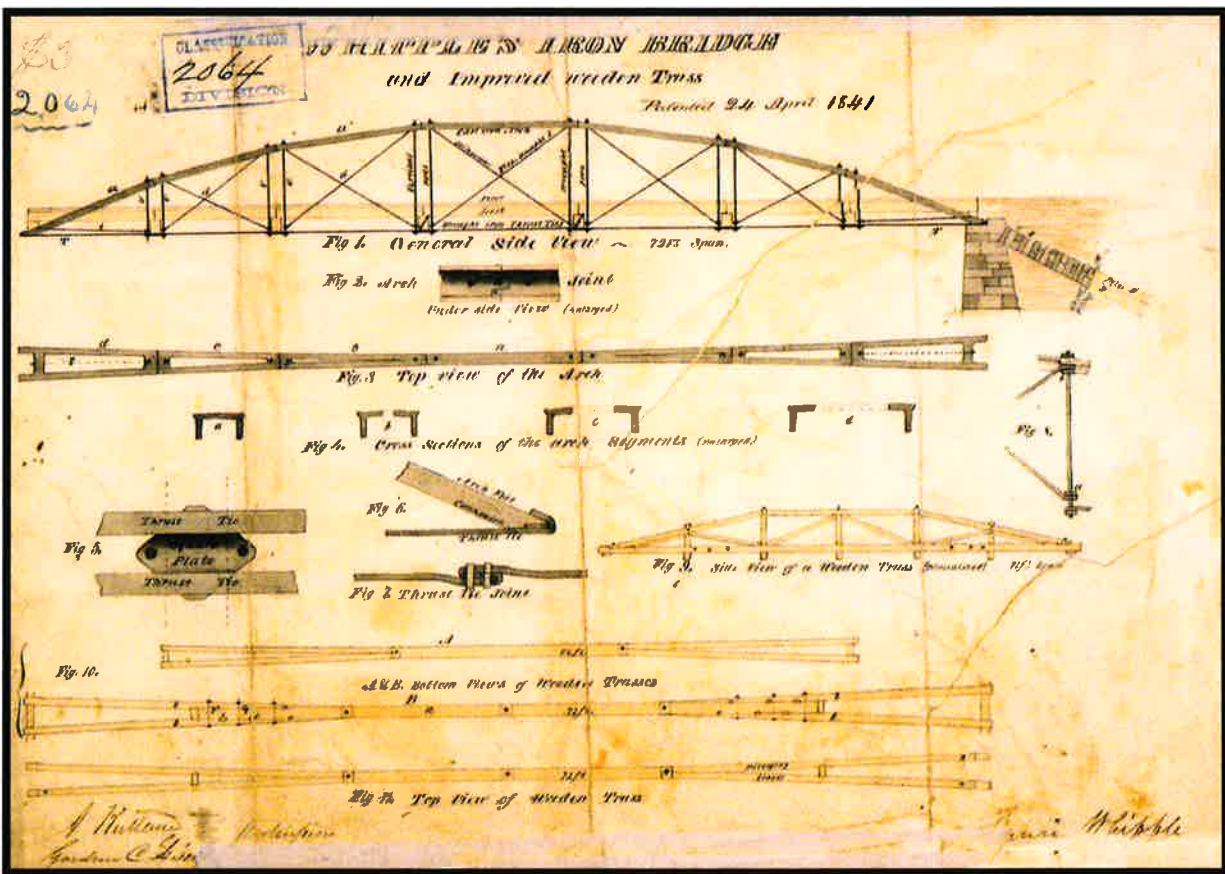

Whipple Patent Application

He went on to build several of these bridges in the 1840s and many more in the 1850s and 1860s. They were adopted by the Canal Commissioners as their standard city bridge.

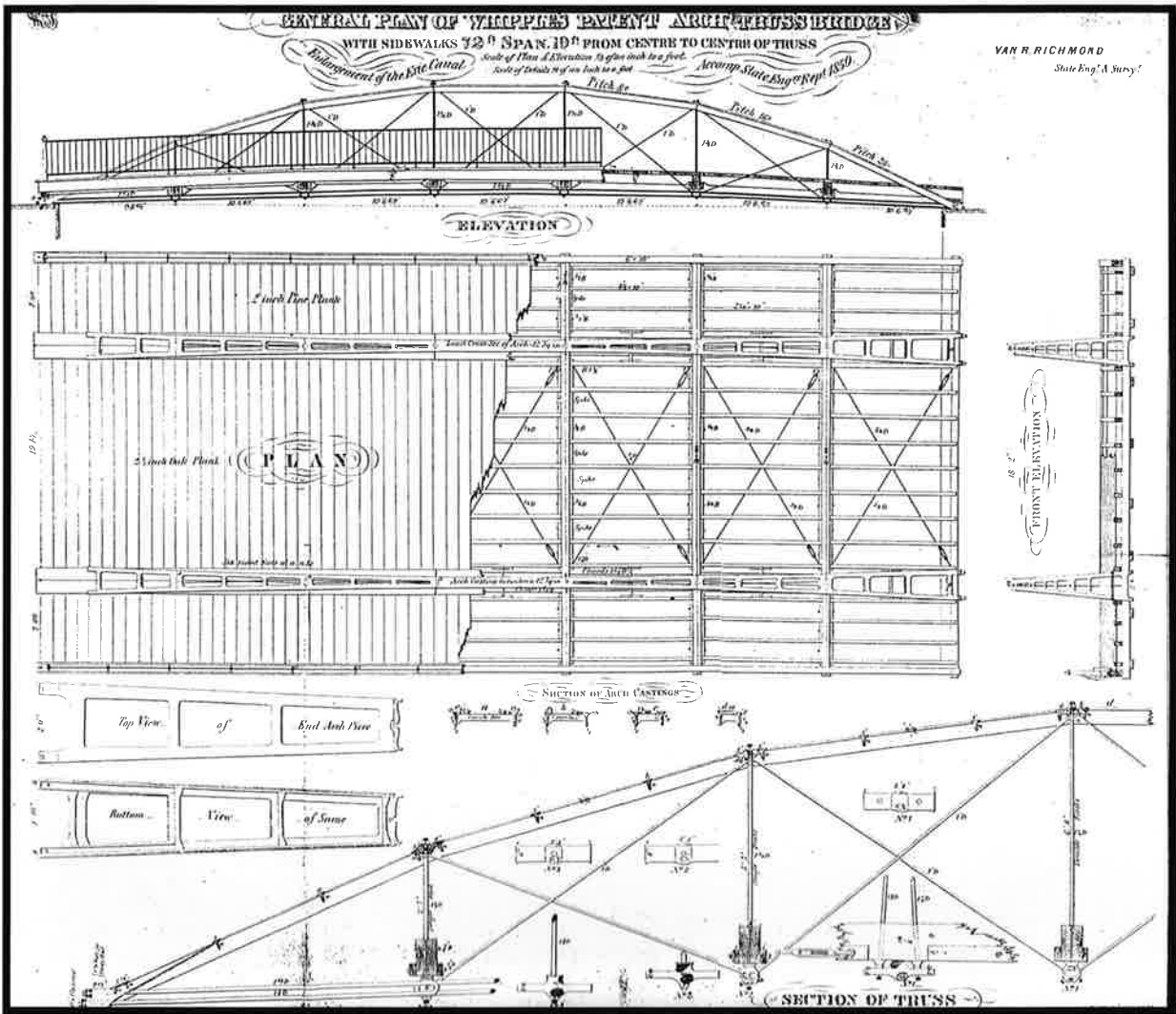

Whipple Patent Arch Bridge adopted by Canal Commissioners in 1855

In 1847 Whipple wrote his Book on Bridge Building based upon his intention to show that his bowstring truss was the best form available in terms of efficient use of material. He wrote, "prior to 1846, or thereabouts, I had regarded the arch formed truss as probably, if not self evidently, the most economical that could be adopted; and at about that time I undertook some investigations and computations with the expectation of being able to demonstrate such to be the fact, but on the contrary the result convinced me that the trapezoidal form, with parallel chords and diagonal members, either with or without verticals, was theoretically more..."

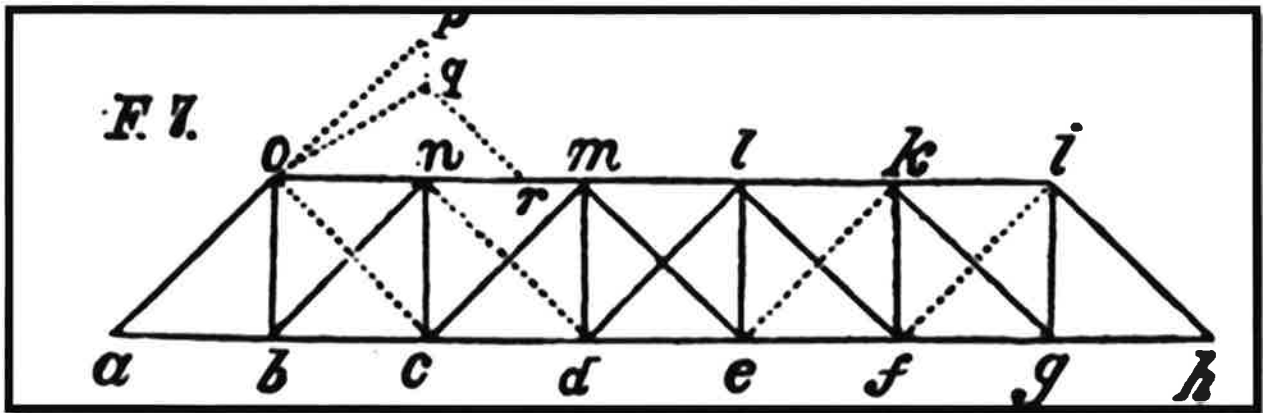

Trapezoidal with verticals from 1847 Book on Bridges

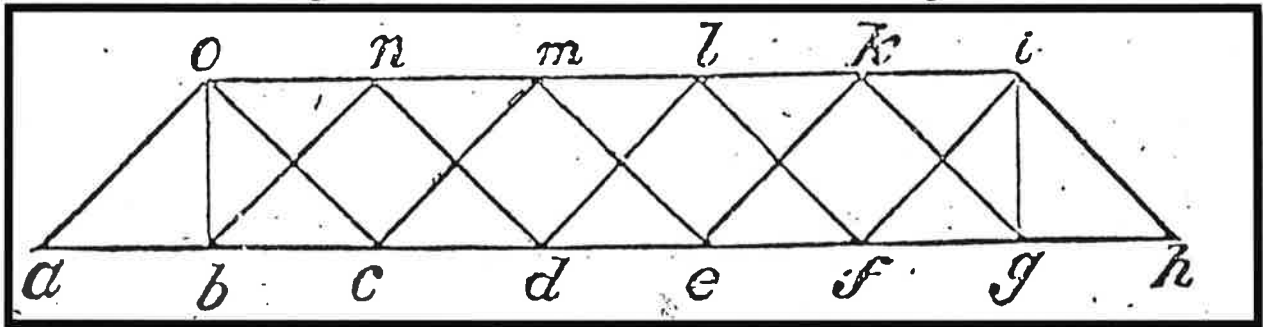

Trapezoidal without diagonals from 1847 Book on Bridges

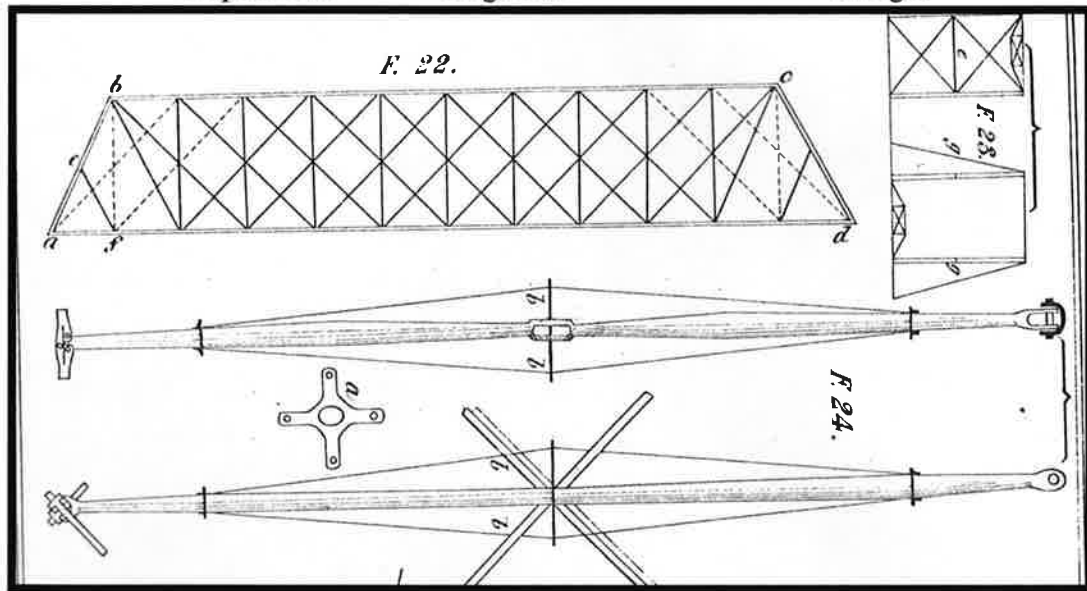

Whipple Double Intersection Truss from 1847 Book on Bridges

He determined that the height of his truss should be approximately $1/7$ of the span and that the diagonals should be close to a 45° angle. As the span length got longer the height of the truss increased. To keep his 45° angles for his diagonals, his panel lengths got long. This resulted in his top chord compression members being increased in size to prevent lateral buckling. In addition, he needed a much heavier deck structure given the increased panel length. To address these problems he developed what he called a double canceled truss (later

double intersection truss) with the diagonals crossing two panels.

His first double intersection bridge in iron crossed the Enlarged Erie Canal just north of its intersection with the Champlain Canal on the then Rensselaer & Saratoga Railroad. It was located just East of lock 2 and was built in 1852-53. The top chords and braced verticals were cast iron cylinders with the lower chord junction blocks also of cast iron. The diagonals and lower chord were wrought iron.

The bridge was 150 feet in length (pin to pin) with a clear span of 147 feet and was built on a 44° skew. It was for a single track carrying 2,000 pounds per foot, which was Whipple's standard railroad loading at the time.

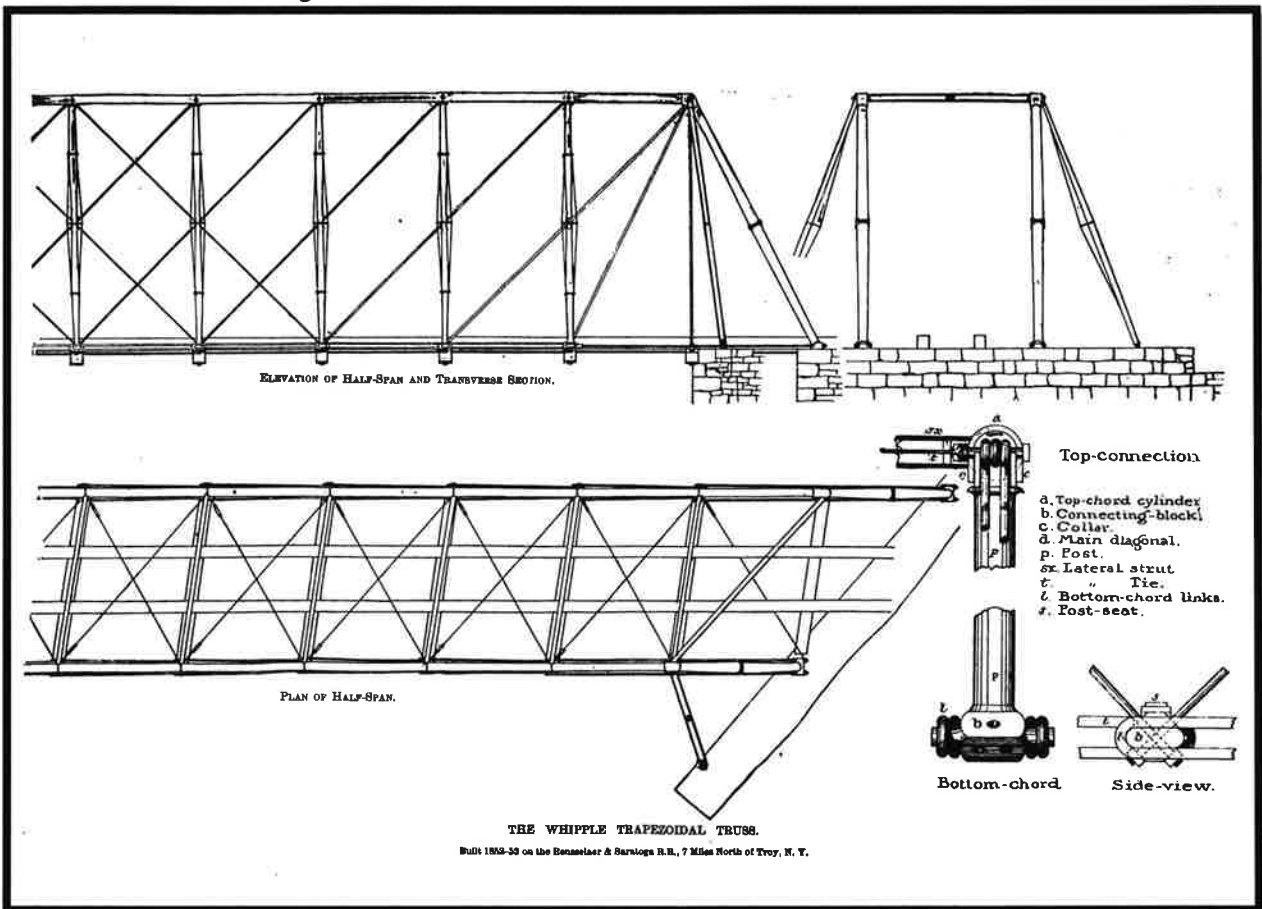

Rensselaer & Saratoga Railroad Bridge, across Erie Canal at West Troy, New York

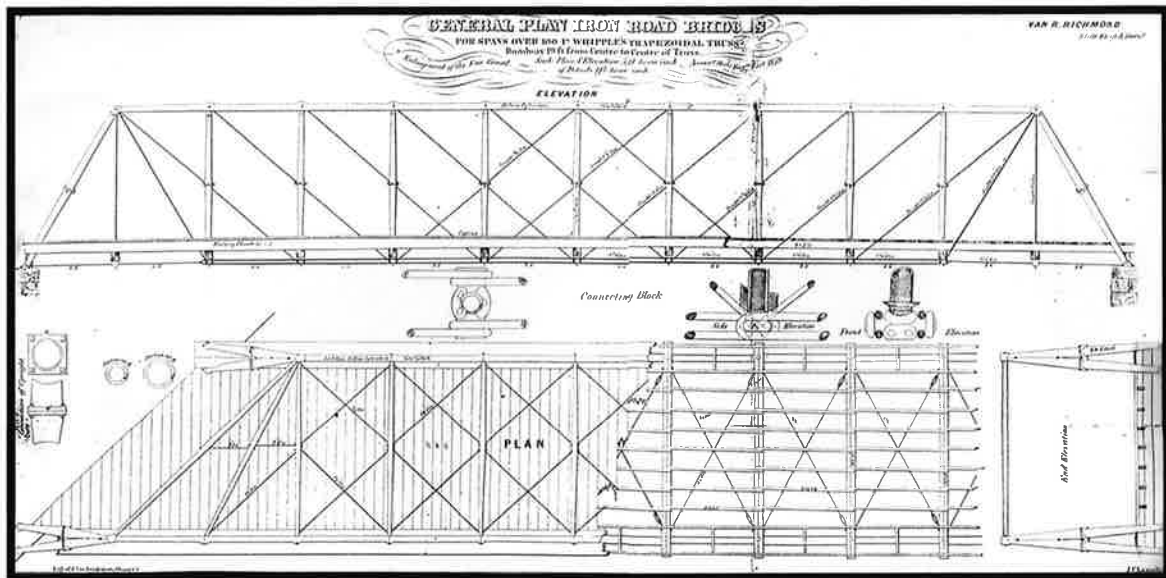

Plan adopted by Erie Canal Commissioners for spans >100'

Whipple built several trapezoidals over the Erie Canal and elsewhere for carriage traffic, but he didn't build another for railroad purposes for many years until he built one in Utica, New York with a span of 123'. Many others, including the Erie Canal Commissioners, picked up on his design that he never took time to patent, even though many writers call it a Whipple Patent Bridge.

John W. Murphy was the next engineer to use the trapezoidal plan. He entered the Rensselaer Institute at the age of 19 in April 1847 and graduated in April 1848 with two degrees, a B.N.S. (Bachelor of Natural Science) and a C.E. degree. He went to work as second assistant and later resident engineer on the eastern section of the Western Division of the Erie Canal Enlargement and was involved with Whipple building his bridges at Albion and Holley in the late 1840s. In 1856 he started building iron bridges on what was to become known as the Murphy-Whipple plan. His first was a 165' span bridge over the Delaware, at Easton, for the Lehigh Valley Railroad and then one of 160' span for the Illinois Central Railroad. Murphy retained the Whipple pattern, using cast-iron cylinders for his top chord and verticals, but he used slightly different links for the lower chord and diagonals while replacing Squire's cast-iron trunnions with wrought-iron pins. When Whipple was asked about Murphy later on in life after Murphy died he wrote:

I first met John W. Murphy about the year 1850 or 1851. I learned that he thought well of my book and my bridges, whence I inferred, of course, that he was a man of discrimination and ability, and as he afterwards talked up iron bridges and Whipple bridges in Pennsylvania, he was of service to the cause and to me. Iron bridges "took" in Pennsylvania rather better than in New York, and Murphy, with others, formed a partnership for building iron bridges, and purchased my patent (covering the arch truss only). In the year 1859, or thereabouts, he built a few bridges, which they were pleased to designate as Murphy-Whipple bridges, to which I made no objections, though it has perhaps been the means of disseminating false impressions. "Murphy-Whipple bridges,"

properly considered, simply means bridges built by Murphy upon plans and principles originated by Whipple. My relations with Mr. Murphy were most friendly, and he conceded to me all my claims to originality in the bridge question.

Murphy would later replace the cast iron members with wrought iron compression members built up with Phoenix Column segments.

James W. Shipman and John D. Hutchinson were builders of the Bridge Street Bridge. Shipman was the nephew of Squire Whipple and had worked with his father in Springfield Center and Vanhornsville New York. He then went west to work with the Coshocton Iron and Steel works in Coshocton, Ohio and the Cincinnati Bridge Company prior to forming the New York Bridge Company. Hutchinson was the son of John D. Hutchinson who built many Whipple Bowstring trusses across the enlarged Erie Canal in the 1850s and 1860s. He was also associated with Shipman in the Cincinnati Bridge Company. While with the Cincinnati Bridge Company they had also been in charge of building Roebling Suspension Bridges across the Great Miami River at Franklin, Ohio and across the Connecticut River at Turners Falls, Massachusetts. The Company went bankrupt shortly after and they reemerged as the New York Bridge Company.

CINCINNATI BRIDGE COMPANY.

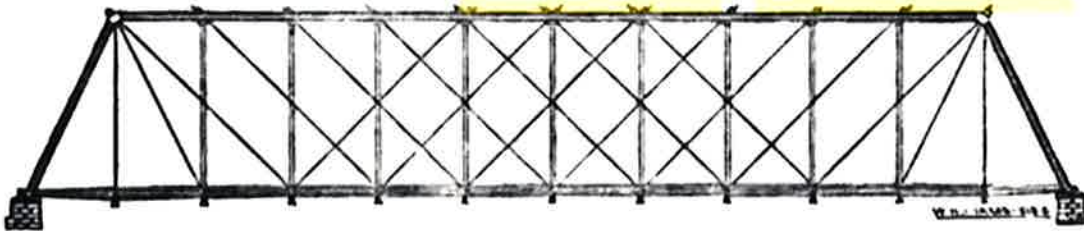

MANUFACTURERS AND BUILDERS OF

Whipple's Iron Truss & Arch Bridges,

FOR RAILWAYS AND HIGHWAYS; ALSO,

ROEBLING'S CELEBRATED STEEL WIRE SUSPENSION BRIDGES.

ALL KINDS BRIDGE IRONS MADE TO ORDER.

Only best quality material used. Send notice of Bridge Lettings.

J. W. SHIPMAN, President and Engineer.

H. A. MANNING, Sec. and Treas.

V. PALMER,

F. N. PALMER,

} Gen. Agents.

J. D. HUTCHINSON, Vice-Pres't and Eastern Manager, Peckskill N. Y.

Address, **CINCINNATI BRIDGE CO.**, 31½ West 3d Street, Cincinnati, C.

Former Company of Shipman & Hutchinson

The New York Bridge Company started building Whipple bridges that used all wrought iron with the compression members built up of riveted plates, channels and angle irons. An

advantage of this was that a paintbrush could reach every square inch of the member. An advertisement of the Company is shown below.

New York Bridge Co.,
CONTRACTORS, BUILDERS,
ENGINEERS,

J. D. HUTCHINSON. J. W. SHIPMAN. ~~NEW YORK~~
Oppen St. *110 BROADWAY, NEW YORK.*

Gentlemen:
We are prepared to furnish the Whipple Iron Truss and Arch Bridges, of any desired length of span and capacity, on short notice, as well as the celebrated "Roobling" Steel Wire Cable Suspension Bridges for long spans, where the nature of bottom makes it difficult to put in masonry, or at localities where it is deemed inexpedient to obstruct the flow of water by putting in piers; also wood and combination bridges. We invite examination of the many bridges in use, put up by us, of the above named plans, and will be pleased to show our work to all parties who may favor us with a call. Plans, Specifications and estimates furnished on short notice.
Notices of all Bridge Projects and Lettings will be esteemed a favor.
Very Truly Yours,

Dec. 1, 1877.

New York Bridge Company Advertisement 1877

Engineering News reported on May 24, 1879,

The New York Bridge Co., of this city, has closed a contract with Chas. M. Wolcott of Matteawan, Dutchess Co., in this state, for the construction of a first-class wrought iron truss bridge of 104 feet span, together with the abutments therefor, over the Fishkill Creek, near A.T. Stewart & Co's carpet mills at Glenham, N.Y.

Charles M. Wolcott was a 19th Century industrialist who owned a part of the New York Rubber Company and the Matteawan Manufacturing Company (a wool hat manufacturer) in the area. He had an estate called Rosemeath located on Wolcott Avenue in Fishkill Landing. Matteawan and Fishkill Landing were later merged to form Beacon in 1913. Glenham is a hamlet near Beacon. A. T. Stewart who was a New York City merchant with a plant on Fishkill Creek also owned plants in the area. In some early reports the bridge was known as Wolcott's Bridge after its owner. The announcement did not say what a first-class wrought iron truss bridge look like. They could have built a 104' span bowstring similar to that adopted by the Erie Canal Commissioners or an iron Pratt truss that was common at the time. But instead, they chose a Whipple Double Intersection Truss with eight panels, and even though it was on the short side for that style truss. It may have been the shortest, and lightest, one of its kind ever built and surely is the oldest of its kind in the United States.

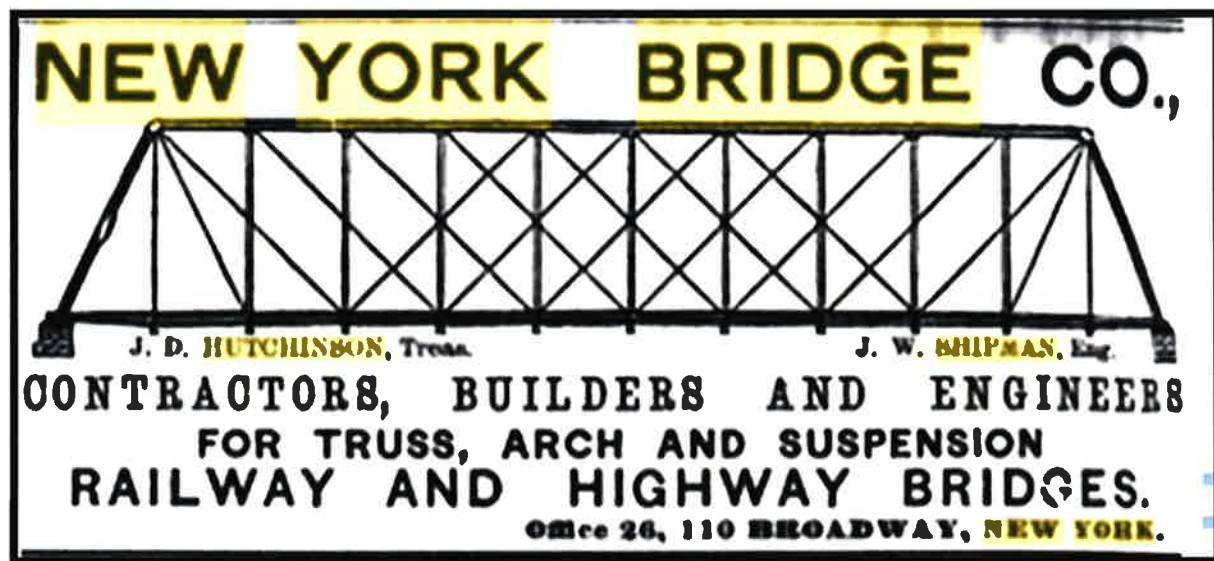

1880 Advertisement

The New York Bridge Company went out of business shortly after the bridge was built and James W. Shipman went on his own for a time and later associated with the Penn Bridge Company. Two other bridges associated with Shipman survive. A Whipple Bowstring Bridge on the Campus of Union College has the nameplate Shipman & Son, Springfield Center. A bridge on the Campus of Ohio State University in Newark was built by the Coshocton Iron Works with whom he was associated. They were both moved from previous locations and restored. Hutchinson has one other extant bowstring bridge; the two span Shaw Bridge in Claverack, New York. It was built in 1870 and is in the process of being rehabilitated in place.

The Bridge Street Bridge is one of oldest, if not the oldest, Whipple Double Intersection truss in New York. Being at its original location is also of historical significance. The Riverside Bridge in Connecticut is 8 years younger (1871) and is a Whipple Double Intersection truss but does not have the distinctive inclined end post. It has cylindrical cast iron top chords, verticals and end posts with wrought iron diagonals and lower chord. It was moved to its current location in 1895. Another example, similar to the Bridge Street Bridge is the 126' span, nine panel Poffenberger Road Bridge, near Jefferson, Maryland over the Catoctin Creek built in 1878 by the

Penn Bridge Company of Beaver Falls, Pennsylvania. It differs in that the diagonals are adjustable in length by screw ends on the upper chord, and in general it is a more complex construction, particularly at the junction of the inclined end post and top chord. On the Bridge Street Bridge the diagonals connect to a pin at both ends and are not adjustable. The lower chords, etc., are similar.

Given its age, connection to Squire Whipple, and its unique truss style at its original location, the Bridge Street Bridge it is a structure well worth restoring and put into use as a pedestrian/bicycle bridge to serve the citizens of Beacon for another 100 years.

Photographic Documentation of Bridge Street Bridge, Beacon, NY

General Views of Bridge



West Portal 2018



East Portal 2018



East Portal 1978 NYSDOT



West Portal 1978 NYSDOT



Side View looking Northerly



Side View Looking Southerly



Bridge Plaque East End



Bridge Plaque West End



Plaque at top Ends of Truss giving date of construction and Finial.

Structural Details

A description of the main structural elements of the bridge follows,

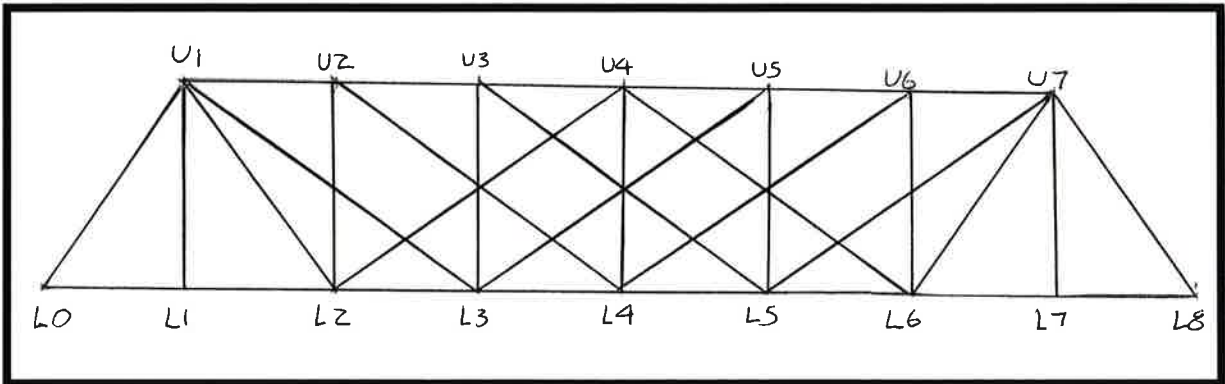

Truss Numbering System. East on left or Fishkill Landing end of Bridge.



Panel L6, U6, U7, L7 (same as L1, U1, U2, L2)



Inclined End Post (top chord identical) L0-U1, L8-U7

These bridge elements consist of a pair of 8" Phoenix Iron Company channels topped with a 12" x 1/4" plate. On the lower flanges of the channels 5" x 12" x 1/4" plates spaced at 4'-0" are used to maintain the spacing of the channels



Inclined end post showing rust bulge, pack rust between top plate and channels, lead paint shown.



Damaged Inclined End Post, Southwest corner of bridge

Pins

Two (2) inch diameter wrought iron pins connect the diagonals and lower chord links together. In addition, the vertical posts are seated on the pins. U-bolts also bear on the pins to support the wrought iron cross beams. The ends of the pins are threaded and held in place by nuts. Very little of the pins are visible to the eye, but those that are visible appear to be intact. A closer look should be made after sand blasting the bridge (if it is decided to sand blast at this time). The fact that there is no sign of deflection, etc. of the bridge indicates that they are most likely performing their design function. If the town is concerned about the pins they should be tested using the FHWA Guidelines for the Ultrasonic Testing of Hanger Pins, Publication No FHWA-HRT-04-042. This testing is beyond the scope of this report.

Rivets

The ½” rivets appear to be sound with no observed loosening, fracturing, etc. A sampling was tested with a hammer and the rest by visual observation.

Vertical Posts

These posts consist of two 5” channels riveted together with single lattice bars. At the top end and bottom end of the channels slots were cut and semicircular holes were drilled to engage the 2” diameter pins. These views also show that there is no physical connection between the verticals and the diagonals. They also show the method used to keep the diagonal spacing.



Vertical Posts and brackets for diagonals



Bottom of posts setting on lower chord pins, and U-Bolts (note bent lower chord member)

Lower chord eyebars



Lower chord eyebars, diagonals, post, diagonal cross bracing, tapered washer and J-bolts to anchor curbing to stringers. L2, L6 (typical) (the web plate at the ends of some of the beams show some section loss at the very ends of the beams).



Top view lower chord eyebars, diagonals, vertical post, latticing and floor beam connection

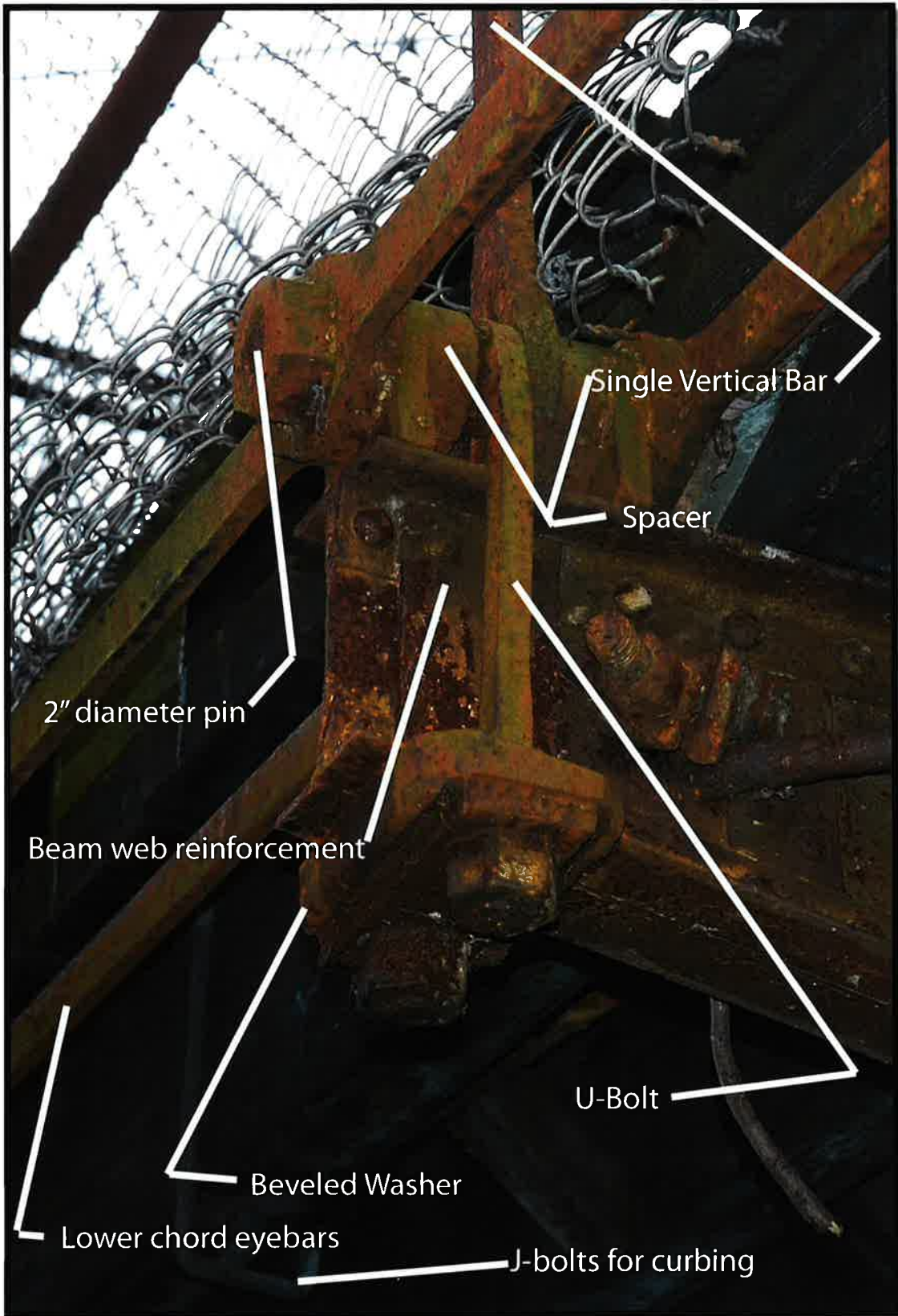

Close up of U-bolt hangers, tapered washers and reinforced end of cross beam (Joint L7 North)

Top chord connections



Connection between inclined end post and top chord showing diagonals, vertical and cast iron portal bracing and cross truss.



Connection vertical post and top chord showing top chord bracing beam and diagonals.



Portal Bracing, wrought iron truss and ornate cast iron tracery (Knee braces)



Cast Iron Tracery - Bolted to Cross Truss and Inclined End Post.

This bracing consists of a variable depth cross truss, built up with angles and double laticing. This cross truss also supports the bridge plaque. Cast iron tracery connects (bolts) to both the inclined end posts, on brackets riveted to the member, and the bottom flanges of the cross truss. In combination these elements keep the main trusses in a vertical position.

Bridge Seats

The cast iron bridge seats connect the ends of the lower chord eyebars, with a pin, and the inclined end posts. As can be seen below the webs of the inclined post channels have been reinforced with 6" plates riveted in place to increase the bearing area of the member. An unusual feature of the bridge is that its seats are not anchored to the masonry or sitting on a nest of rollers which was common at the time. In other words the bridge sits on masonry with no physical connection other than gravity.

Southwest Corner



Southwest bridge seat end and side views



Southwest bridge seat under view (note poison ivy root system)
Northwest Corner





Northwest Bridge Seat



Image under northwest bridge shoe showing bearing surface on cast iron shoe, lower chord links. Note there is no additional bearing plate added to inside face of channels. Pin behind cross plate. Angle on bottom to receive hand railing

Northeast Corner



Northeast bridge seat

Southeast Corner





Southeast bridge seat end and side views



Underside of Southeast bridge seat. Note broken 5 " x 12" plate that should be replaced with new plate farther up the member.

Deck Construction

The variable depth 18' long wrought iron crossbeams are hung from pins on the lower chord with U-bolts. They in turn support 14- 4" x 11 1/4" wooden stringers (apparently creosoted). The stringers appear to be in good condition with little sign of decay. Transverse to the stringers, the decking consists of 3" x 11" planks spiked to the stringers. The under floor diagonal bracing consists of 7/8" diameter bars and wooden bridging. A wooden curb is set on the decking and is anchored to the stringers below with J-bolts.

The decking is worn in two tracks and some members are rotting on the surface but generally the wood is sound and firmly attached to the stringers. The maximum depth of rut is approximately 1 1/2" with the edges of the planking and along the centerline at, or near, original elevation. The centerline of the southerly rut is about 6' in from the edge with the centerline of the northerly rut another 4+ feet to the north.



Deck with ruts, with some decay in the rut where water puddles. Depth of rut ~1 1/2".



Rut on northerly side of centerline of the bridge showing ~1 ½" depression.



Deck and Curb 1978 NYSDOT

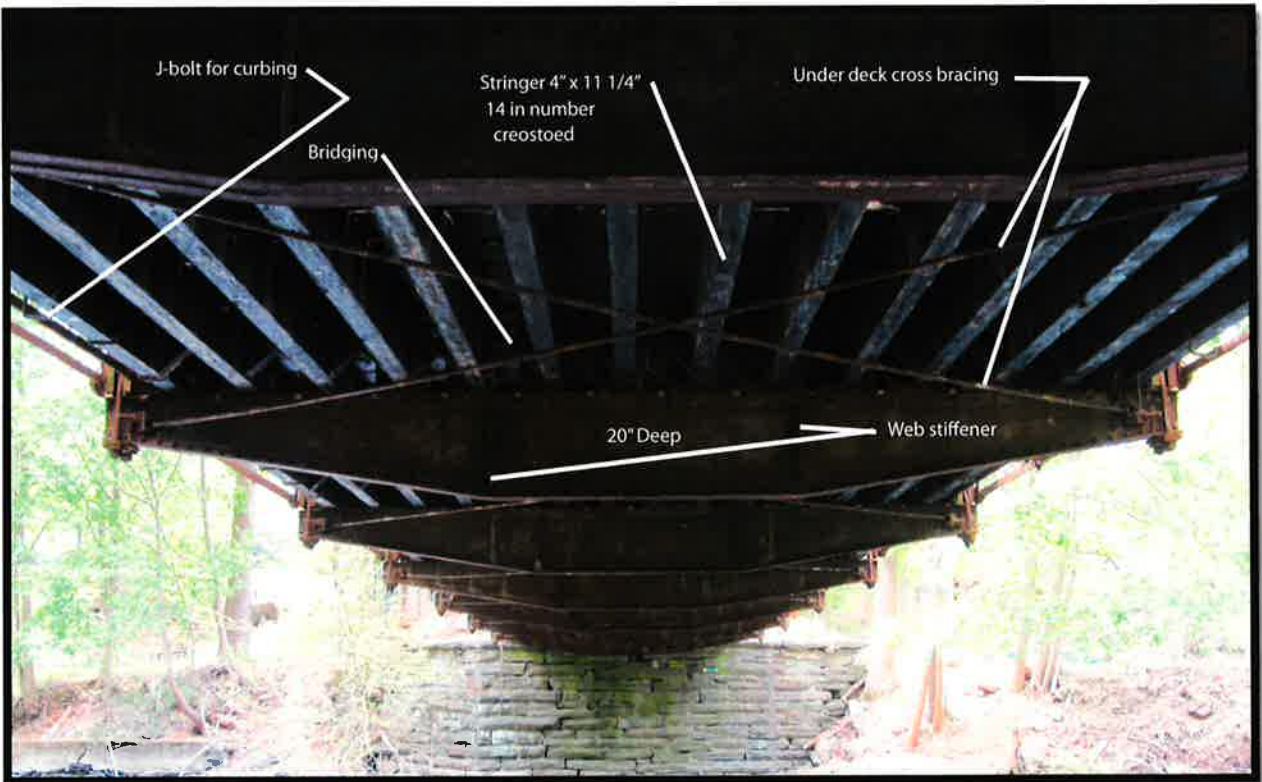

Deck Construction showing iron cross beams, diagonal bracing, stringers and bridging.



Wooden decking, curb and pipe railing, diagonal, note little decay along edges of decking. Note also organic material collecting in joints. It will be noted later on that this material should be power washed away to minimize further decay in the joint.

Abutments

West

This abutment is built of cut stone and the joints mortared up. It is 21' 3" wide with wing walls of 11' 4" on the south and 15' 5" on the north. Exposed stone varies from 7' 0" to 10' 7" high. The end of the truss is set back ~2' 3" from the face of the wall.



Southerly Wing wall, showing good line of face of abutment



Face of west abutment showing pointed stonework



North wing wall of westerly abutment

East

This abutment is also built of cut stone with the joints mortared. The creek waterline flows along the face of the stonework, but there is no sign of significant erosion. It is also 21' 3" wide with wing walls of 16' 7" on the south and about the same on the north. The end of the truss is set back ~2' 7" from the face of the wall making the distance between abutments approximately 100'.



East abutment taken from west abutment



Southerly wing wall, tree should be removed as it is displacing the stonework and stone pushed back to original position



Face of easterly wing wall, excellent condition



BIN Number of Bridge

New York State DOT Inspection Sketches from 1978 and 1989

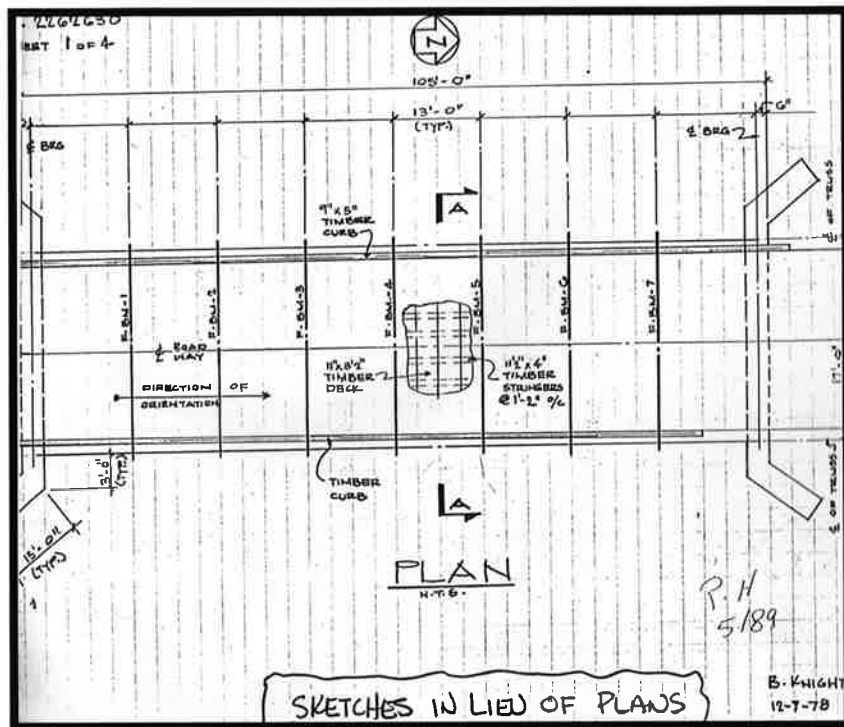

NYS DOT Inspection sketch 1978 and repeated in 1989 Inspection

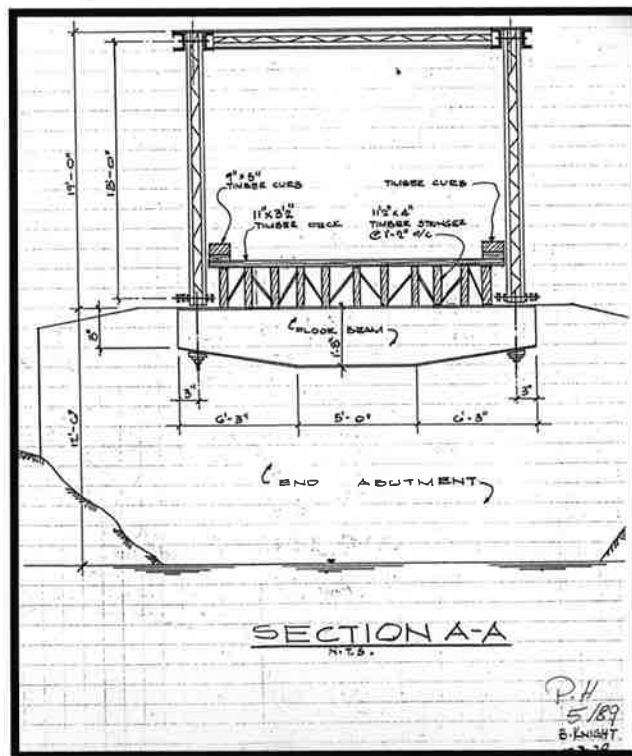

NYS DOT Inspection sketch 1978 and repeated in 1989 Inspection

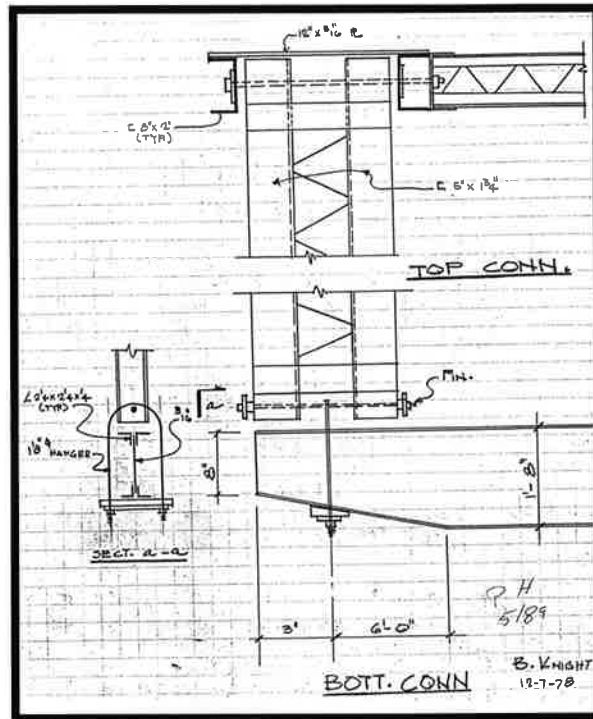

NYSDOT Inspection sketch 1978 and repeated in 1989 Inspection

The State of New York DOT inspected the bridge in 1978, 1985, 1987 and 1989 after it was abandoned. The 1978 report included the sketches shown above as well as some of the pictures shown in the Photographic Documentation section. Most of the inspections did not mention any specific problems only giving a rating of each part of the bridge.

The main item of concern in the 1989 inspection report was in what they called the primary members. They noted, “built in 1879 and with total absence of paint, the structural steel [wrought iron] is remarkable in that it has so little section loss, minor in most cases except as follows,

1. All four end posts have had repair plates welded to both the webs and to the top flanges.
2. All four end posts have 100% thickness loss in the top flange plate near the end of plate at bearing.
3. Member U1L1 [our U7L8] has been hit and deflected in turn deflection and skewing the floor beam connection at L2 [our L8]. The joint is still fast.
4. Top flange of the top chord of both trusses is rippled from crevice corrosion full length.”

No inspections have been held since 1989 as the bridge was listed as abandoned. They did issue a Safety Alert as the bridge was still being used by pedestrians and the chain link fence that was strapped to the truss work and was not functional.

These comments are still valid in 2018 thirty years after these reports. My dimensions of the bridge generally agree with those of the State Engineers. Note they had the bridge in a north south direction while I assumed an east west orientation.

1977 Report

In 1977 a report on the bridge was submitted by Eberlin & Eberlin, PC, Consulting Engineers, Planners and Landscape Architects, 30 East 42nd Street, New York, New York, 10007. After a search by the City the file, which was supposed to have been filed with the Churchill Bridge, was not found.

Structural Analysis

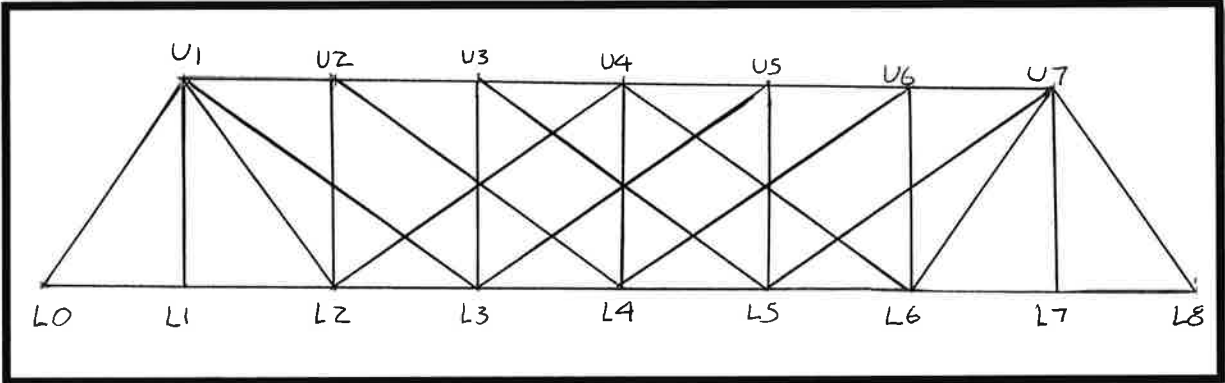

Truss Numbering System

TRUSS MEMBER INFORMATION SHEET		
Member #	Description of member	Size members
L0-L1	Two rectangular bars	2@ .60" x 1.82"
L1-L2	Two rectangular bars	2@ .692" x 1.82"
L2-L3	Two rectangular bars	2@ .875" x 2.607"
L3-L4	Two rectangular bars	2@ .875" x 2.607"
L4-L5	Two rectangular bars	2@ .875" x 2.607"
L5-L6	Two rectangular bars	2@ .875" x 2.607"
L6-L7	Two rectangular bars	2@ .692" x 1.82"
L7-L8	Two rectangular bars	2 @ .60" x 1.82"
U1-U2	Two chanel, top plate, lattice	see attached sketch a
U2-U3	Two chanel, top plate, lattice	see attached sketch a
U3-U4	Two chanel, top plate, lattice	see attached sketch a
U4-U5	Two chanel, top plate, lattice	see attached sketch a
U5-U6	Two chanel, top plate, lattice	see attached sketch a
U6-U7	Two chanel, top plate, lattice	see attached sketch a
L0-U1	Two chanel, top plate, lattice	see attached sketch a
U1-L1	One Square bar	1.05" x 1.05"
U1-L2	Two rectangular bars	2 @ 1.5" x .5"
U1-L3	Two rectangular bars	2 @ 1.5" x .5"
U2-L2	Two latticed chanel	see attached sketch b
U2-L4	Two round bars	2 @ 1.5" x .5"
U3-L3	Two latticed chanel	see attached sketch b
U3-L5	Two rectangular bar	2 @ 1.28" x .52"
U4-L6	One round bar	0.718"
U4-L4	Two latticed chanel	see attached sketch b
L2-U4	One round bar	0.718"
L3-U5	Two rectangular bars	2 @ 1.5" x .5"
L4-U6	Two rectangular bars	2 @ 1.5" x .5"
U5-L5	Two latticed chanel	see attached sketch b
U5-L3	Two rectangular bars	2 @ 1.28" x .52"
L5-U7	Two rectangular bars	2 @ 1.5" x .5"
U6-L6	Two latticed chanel	see attached sketch b
L6-U7	Two rectangular bars	2 @ 1.5" x .5"
U7-L7	One square bar	1.05" x 1.05"
U7-L8	Two chanel, top plate, lattice	see attached sketch a
Floor Beams	Trapezoidal built up beam	see attached sketch c
Stringers size	14 beams	4" x 11.25"
Stringers spacing		14.5"
Bracing top, truss	Round bars crossed	.874"
Bracing Cross bear	four angles latticed	see attached sketch d
Bracing deck diag.	Round bars crossed	0.875"
Truss Height		18'
Truss spacing		17'
Width of decking	Boards	16'
Decking	Boards	3" x 11.5"
Curb to curb		14' 5"

Member Properties

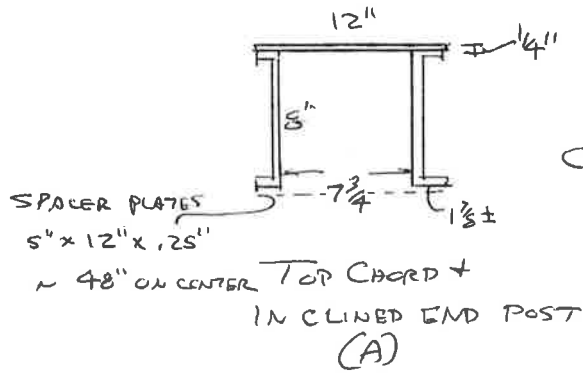

CHANNEL = 8" DEEP, FLANGE 1 7/8"
THICKNESS ~ .376
PHOENIX SECTION

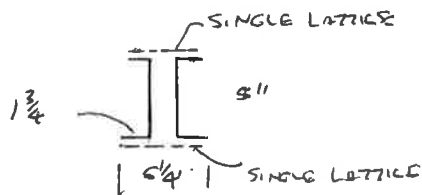

CHANNELS 8" DEEP, 1 3/4" LG
THICKNESS ~ .376

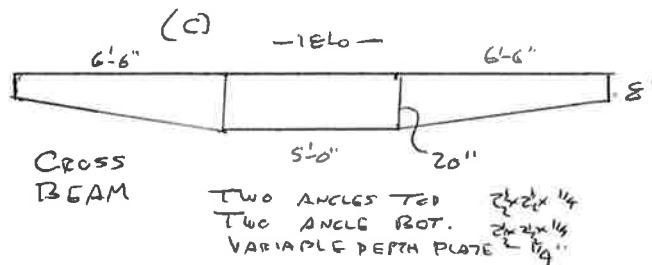
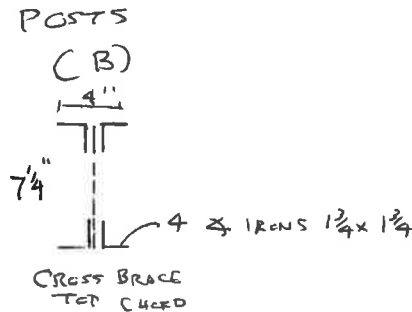

Detail Sketches of built up members

Dan DeGennaro Report

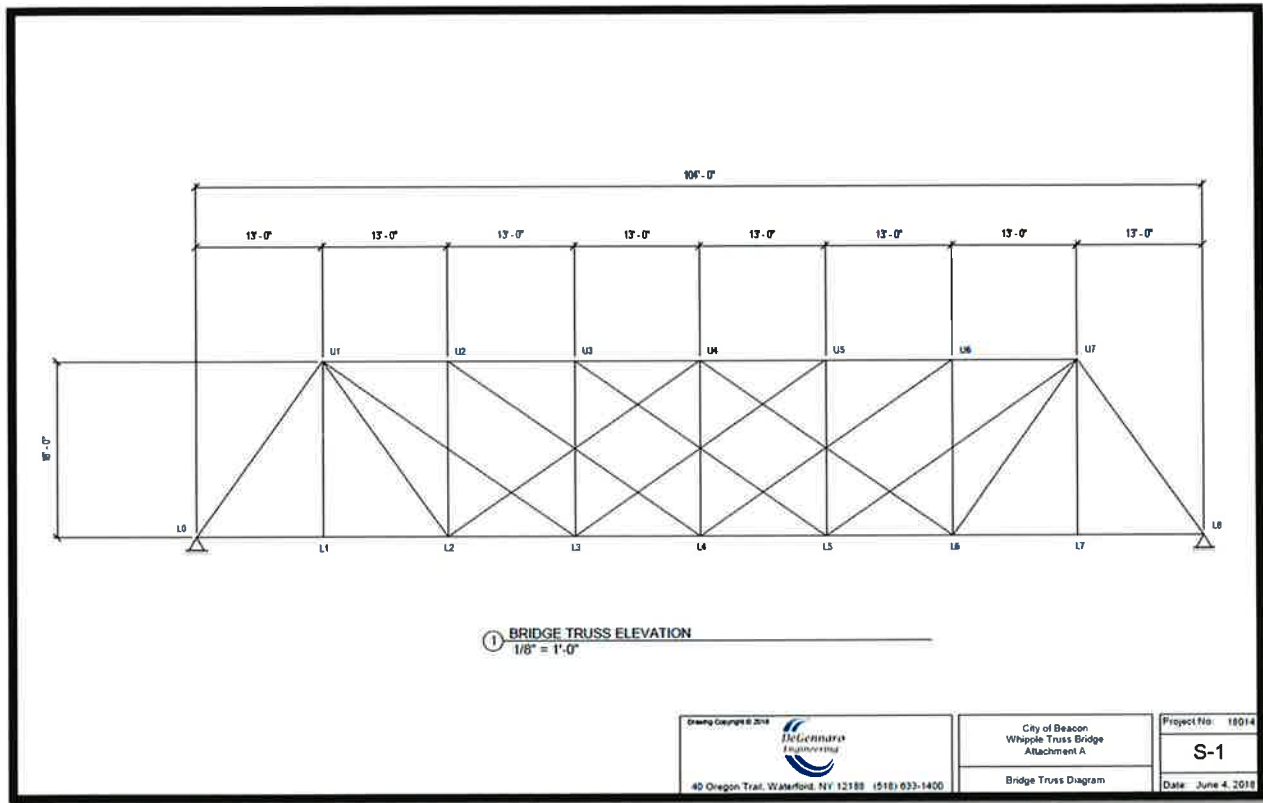

Bridge truss diagram

Report

To: Dr. Frank Griggs, Jr. Dist. M. ASCE

From: Daniel J. DeGennaro, PE

Subject: Bridge Street Whipple Truss Bridge, Beacon, NY
Preliminary Bridge Truss Analysis
DE Project No. 18014

Date: June 2, 2018

The Bridge Street Bridge is a single-span, Whipple-type truss bridge built by the New York Bridge Company in 1879 that is located in Beacon, NY. The bridge has span of 104-ft and crosses over the Fishkill Creek on Bridge Street. The purpose of this memo is to document a preliminary structural analysis completed on the bridge to assist with rehabilitation planning for reuse of the bridge for pedestrians. Refer to Attachment A for a diagram of the bridge truss.

Based on provided field measured dimensions, the bridge trusses were analyzed to determine the load on each truss member. The computer program Risa-3D was used for the analysis. The calculated load on each member was compared to an allowable load to determine if allowable stresses were exceeded.

The dead load used in the analysis includes the self-weight of bridge components with 21 psf used for the wood decking and stringers.

The live load used in the analysis is 85 pounds per square foot, which is the required pedestrian bridge design live load in accordance with the American Association of State Highway and Transportation Officials (AASHTO) Guide Specification for the Design of Pedestrian Bridges.

Two separate load live load cases were considered on the bridge truss. Case 1 analysis used a 14'-5" wide deck subject to an 85 psf live load. Case 2 analysis used a 11'-0" wide deck subject to an 85 psf live load. The results of Case 1 and Case 2 analysis are summarized in Table 1 and 2. The analysis assumes that the bridge will not be subject to vehicular live load and that bollards or other guards will be constructed to prevent vehicle access.

The capacity of the individual truss members is based upon the allowable stress method. The following material properties were used for wrought iron:

- Allowable tensile stress = 12.5 ksi
- Allowable compressive force top chord = 12 ksi
- Allowable compressive force verticals = 4.9 ksi
- Modulus of Elasticity = 28,000 ksi

The material properties and allowable stresses used are based upon historical references for material in general at the time the bridge was originally constructed and are not based on testing actual samples of material taken from the bridge.

As shown in the results on Table 1, a pedestrian live load of 85 psf on a 14'-5" wide wood deck results in a demand / capacity ratio greater than 1.0 on six of the members on each bridge truss. A demand / capacity ratio of 1.10 is calculated for two of the bottom chord members, a demand capacity ratio of 1.17 for two of the diagonal members, and a demand capacity ratio of 1.12 for two of the diagonal members. Based on the calculated stresses a 14'-5" wide deck is not recommended since the demand ratio is greater than 1.00 for six of the truss members.

A live load on a 11-ft wide wood deck results in a demand ratio of less than 1.0 for all members as indicated on Table 2. This analysis indicates that the trusses are adequate to support an 11-ft wide wood deck and the required live load. An updated and final structural analysis will be required during the bridge rehabilitation design phase.

BEACON PEDESTRIAN BRIDGE
 TRUSS MEMBER AXIAL FORCES
 LOAD CASE 1: DEAD LOAD + 85 PSF LIVE LOAD ON 14'-5" WOOD DECK
 June 4, 2018

TABLE 1

	Member	Dead Load + Live Load (kips)	Allowable Member Capacity	Ratio of Demand / Capacity	Member Size	Member Area (sq. inch)
Bottom Chord	L0-L1	30.14	27.300	1.10	(2) 0.60" x 1.82" Rect Bars	2.184
	L1-L2	30.11	31.488	0.96	(2) 0.692" x 1.82" Rect Bars	2.519
	L2-L3	42.92	57.025	0.75	(2) 0.875" x 2.607" Rect Bars	4.562
	L3-L4	58.61	57.025	1.03	(2) 0.875" x 2.607" Rect Bars	4.562
	L4-L5	58.61	57.025	1.03	(2) 0.875" x 2.607" Rect Bars	4.562
	L5-L6	42.92	57.025	0.75	(2) 0.875" x 2.607" Rect Bars	4.562
	L6-L7	30.11	31.488	0.96	(2) 0.692" x 1.82" Rect Bars	2.519
	L7-L8	30.14	27.300	1.10	(2) 0.60" x 1.82" Rect Bars	2.184
Top Chord	U0-U1	-51.62	-114.36	0.45	Type A - Built-up 8" Double Channels w/ Top Plate	9.53
	U1-U2	-60.08	-114.36	0.53	Type A - Built-up 8" Double Channels w/ Top Plate	9.53
	U2-U3	-68.65	-114.36	0.60	Type A - Built-up 8" Double Channels w/ Top Plate	9.53
	U3-U4	-70.14	-114.36	0.61	Type A - Built-up 8" Double Channels w/ Top Plate	9.53
	U4-U5	-70.14	-114.36	0.61	Type A - Built-up 8" Double Channels w/ Top Plate	9.53
	U5-U6	-68.65	-114.36	0.60	Type A - Built-up 8" Double Channels w/ Top Plate	9.53
	U6-U7	-60.08	-114.36	0.53	Type A - Built-up 8" Double Channels w/ Top Plate	9.53
	U7-U8	-51.62	-114.36	0.45	Type A - Built-up 8" Double Channels w/ Top Plate	9.53
Verticals	U1-L1	10.74	13.813	0.78	1.05" x 1.05" Rect Bar	1.105
	U2-L2	-6.93	-17.297	0.40	Type B Built-up Double 5" Channels	3.53
	U3-L3	-2.16	-17.297	0.12	Type B Built-up Double 5" Channels	3.53
	U4-L4	-0.96	-17.297	0.06	Type B Built-up Double 5" Channels	3.53
	U5-L5	-2.16	-17.297	0.12	Type B Built-up Double 5" Channels	3.53
	U6-L6	-6.93	-17.297	0.40	Type B Built-up Double 5" Channels	3.53
	U7-L7	10.74	13.813	0.78	1.05" x 1.05" Rect Bar	1.105
	U1-L2	21.98	18.750	1.17	(2) 1.5" x 0.5" Rect Bars	1.5
Diagonals	U1-L3	20.99	18.750	1.12	(2) 1.5" x 0.5" Rect Bars	1.5
	U2-L4	10.46	18.750	0.56	(2) 1.5" x 0.5" Rect Bars	1.5
	U3-L5	1.85	16.625	0.11	(2) 1.28" x 0.52" Rect Bars	1.33
	U4-L2	0.00	5.000	0.00	0.718" Dia Bar	0.4
	U4-L6	0.00	5.000	0.00	0.718" Dia Bar	0.4
	U5-L3	1.85	16.625	0.11	(2) 1.28" x 0.52" Rect Bars	1.33
	U6-L4	10.46	18.750	0.56	(2) 1.5" x 0.5" Rect Bars	1.5
	U7-L5	20.99	18.750	1.12	(2) 1.5" x 0.5" Rect Bars	1.5
	U7-L6	21.98	18.750	1.17	(2) 1.5" x 0.5" Rect Bars	1.5
	End Reaction		42.11			

Positive Force = Tension

Negative Force = Compression

Wrought Iron Allowable Tension Force = 12,500 psi

Wrought Iron Allowable Compressive Force = 12,000 psi for Top Chord and 4,900 psi for Verticals

Dead Load = 21 PSF for Wood Decking and Stringers, Selfweight of Members, 20 PLF for guardrail with 16'-0" Trib width

Live Load Width = 16'-0" - guardrails = 14'-5"

14' 5" Deck

BEACON PEDESTRIAN BRIDGE
 TRUSS MEMBER AXIAL FORCES
 LOAD CASE 2: DEAD LOAD + 85 PSF LIVE LOAD ON 11'-0" WOOD DECK
 June 4, 2018

TABLE 2

	Member	Dead Load + Live Load (kips)	Allowable Member Capacity	Ratio of Demand / Capacity	Member Size	Member Area (sq. inch)
Bottom Chord	L0-L1	21.86	27.300	0.80	(2) 0.60" x 1.82" Rect Bars	2.184
	L1-L2	21.85	31.488	0.69	(2) 0.692" x 1.82" Rect Bars	2.519
	L2-L3	31.13	57.025	0.55	(2) 0.875" x 2.607" Rect Bars	4.562
	L3-L4	42.55	57.025	0.75	(2) 0.875" x 2.607" Rect Bars	4.562
	L4-L5	42.55	57.025	0.75	(2) 0.875" x 2.607" Rect Bars	4.562
	L5-L6	31.13	57.025	0.55	(2) 0.875" x 2.607" Rect Bars	4.562
	L6-L7	21.85	31.488	0.69	(2) 0.692" x 1.82" Rect Bars	2.519
	L7-L8	21.86	27.300	0.80	(2) 0.60" x 1.82" Rect Bars	2.184
Top Chord	U0-U1	-37.61	-114.36	0.33	Type A - Built-up 8" Double Channels w/ Top Plate	9.53
	U1-U2	-46.62	-114.36	0.41	Type A - Built-up 8" Double Channels w/ Top Plate	9.53
	U2-U3	-49.84	-114.36	0.44	Type A - Built-up 8" Double Channels w/ Top Plate	9.53
	U3-U4	-50.91	-114.36	0.45	Type A - Built-up 8" Double Channels w/ Top Plate	9.53
	U4-U5	-50.91	-114.36	0.45	Type A - Built-up 8" Double Channels w/ Top Plate	9.53
	U5-U6	-49.84	-114.36	0.44	Type A - Built-up 8" Double Channels w/ Top Plate	9.53
	U6-U7	-46.62	-114.36	0.41	Type A - Built-up 8" Double Channels w/ Top Plate	9.53
	U7-U8	-37.61	-114.36	0.33	Type A - Built-up 8" Double Channels w/ Top Plate	9.53
Verticals	U1-L1	7.52	13.813	0.54	1.05" x 1.05" Rect Bar	1.105
	U2-L2	-5.28	-17.297	0.31	Type B Built-up Double 5" Channels	3.53
	U3-L3	-1.77	-17.297	0.10	Type B Built-up Double 5" Channels	3.53
	U4-L4	-0.93	-17.297	0.05	Type B Built-up Double 5" Channels	3.53
	U5-L5	-1.77	-17.297	0.10	Type B Built-up Double 5" Channels	3.53
	U6-L6	-5.28	-17.297	0.31	Type B Built-up Double 5" Channels	3.53
	U7-L7	7.52	13.813	0.54	1.05" x 1.05" Rect Bar	1.105
	Diagonals	U1-L2	15.94	18.750	0.85	(2) 1.5" x 0.5" Rect Bars
U1-L3		15.26	18.750	0.81	(2) 1.5" x 0.5" Rect Bars	1.5
U2-L4		7.62	18.750	0.41	(2) 1.5" x 0.5" Rect Bars	1.5
U3-L5		1.34	16.625	0.08	(2) 1.28" x 0.52" Rect Bars	1.33
U4-L2		0.00	5.000	0.00	0.718" Dia Bar	0.4
U4-L6		0.00	5.000	0.00	0.718" Dia Bar	0.4
U5-L3		1.34	16.625	0.08	(2) 1.28" x 0.52" Rect Bars	1.33
U6-L4		7.62	18.750	0.41	(2) 1.5" x 0.5" Rect Bars	1.5
U7-L5		15.26	18.750	0.81	(2) 1.5" x 0.5" Rect Bars	1.5
U7-L6		15.94	18.750	0.85	(2) 1.5" x 0.5" Rect Bars	1.5
End Reaction		30.73				

Positive Force = Tension

Negative Force = Compression

Wrought Iron Allowable Tension Force = 12,500 psi

Wrought Iron Allowable Compressive Force = 12,000 psi for Top Chord and 4,900 psi for Verticals

Dead Load = 21 PSF for Wood Decking and Stringers, Selfweight of Members, 20 PLF for guardrail

11' Deck

Structural evaluation, recommendations and Tentative Cost Estimates

I made an intensive visual evaluation of the entire structure first globally and then in detail. Globally I found the trusses to be perfectly plumb indicating no lateral shifting. There was no sign of settlement or deflection of the trusses indicating they were performing their design function regarding their ability to carry their loads successfully. All of the diagonal bars are taut with no sign of section loss that would impact their capacity to resist tension loads.

I then studied the connections with special attention paid to the ends of the truss where it sits on the masonry abutment, as it is generally the case that if a bridge fails it is in the connections. It was difficult to get a good look at some of the lower chord connections due to the chain link fencing mounted on the bridge. In spite of that, I was able to closely inspect each connection from the deck. There was no indication of cracking on any of the lower chord eyebars, diagonals or verticals. Another closer investigation of these connections should be made in the future if the bridge is sandblasted and prior to painting. The top chord connections also were in excellent condition.

Next, I made observations of each bridge element between connections. The only problems observed were at the bridge seats and inclined end post area at each corner of the bridge. At the southwest end of the bridge the inclined end post had been hit by a motor vehicle in the past. This impact not only deformed the inside channel of the member but shifted the member on the cast iron shoe such that the channels do not have full bearing on the shoe. This impact also shifted the bridge joint L7 and twisted to a small degree the end of the cross beam.



Damaged inclined end post, southwest corner of bridge. Also previously welded plate at top end of image. Some yellow lead paint remains. The lower ~8' of the inclined end posts were painted yellow for visibility purposes



End post shifted on cast iron shoe resulting in less than full bearing. Note web plate riveted on web of channel to increase bearing still has full bearing. Member was not deflected transversely, only longitudinally.

On the other three inclined posts, where they connect with cast iron shoes, the top plate of the member had partly corroded through as can be seen above. This corrosion is mainly cosmetic and does not greatly impact the load carrying capacity of the inclined end chords, as the top plate's primary function is to maintain the orientation and separation of the two channels. One quarter inch $\frac{1}{4}$ " cover plates should, however be welded on the existing top flange plates as described below. The angle iron on the northeast and southeast inclined end post should be removed in order to place new cover plates. On the southwest end the plate should be $\frac{1}{2}$ " thick and in direct contact with the cast iron bridge shoe to make up for some of the bearing area lost on the lower flange of the channels.

Rehabilitation – General

It is assumed the City wants to maintain the historical aspects of this 140-year old wrought iron bridge that is setting on the original abutments and maintains the original design elements from 1879.

The existing decking is much wider than needed for a pedestrian/bicycle bridge. The report by Dan DeGennaro, PE indicates a narrow (11' curb to curb) deck would keep the loads in the truss members in a safe range while the existing 14' 5" deck would over load some members. It is therefore recommended that the deck width be narrowed to 12' (~11' curb to curb) from the existing 16'. This will also accentuate the late 19th century lower chord wrought iron truss details. In addition, it will, as noted, cut down on the dead load and the potential live load reducing the loading on the bridge trusses. It will also make it possible to have the bridge seats

entirely in the open thus minimizing corrosion in the future. It is further recommended that a new pedestrian/bicycle railing be placed on the bridge.

The restoration can be carried out in two ways. Proposal 1 would get the bridge back in use the fastest and at the lowest cost while Proposal 2 would restore the bridge to its near original condition.

A recommended sequence of actions for Proposal 1 is as follows,

Proposal 1

1. Pressure wash decking removing any material between the deck planks as well as any decayed wood on the planks. Drill holes in each plank at the low spot of the ruts to permit drainage.
2. At the lower ends of the northwest, northeast and southeast inclined end posts weld 8" x 32" x 1/4" mild steel plates to span the corroded portions. (I would suggest a 3/32" - 7018 electrode.) On the southwest inclined end post weld an 8" x 32" x 1/2" plate to add bearing area to replace the bearing area on the lower flange of the channels. Weld new under lattice plate at the southeast bridge seat. Remove angle iron on the top chord of the northeast and southeast ends of the trusses.
3. Straighten the channel flange, jack and heat method, and top plate of the inclined post at the southwest corner of the bridge. It may be prudent to support U7 with a crane during this process.
4. Remove soil, etc. around existing cast iron end shoes.
5. Remove chain link fencing and existing railing.
6. Remove outer 2' 0" of existing decking on each side of bridge as shown below.
7. Shim tire rut depressions with two longitudinal treated lumber, ~2" x 6", spaced ~4' 0" apart, as necessary to support new decking on an even plane. Screw 2" x 6" treated decking to existing planks. Space new decking pieces so every other joint lines up with existing planking joints below for drainage purposes.
8. Install old curbing to new decking as shown below. Place new curbing as required matching existing.
9. Install new 42" high bicycle railing.

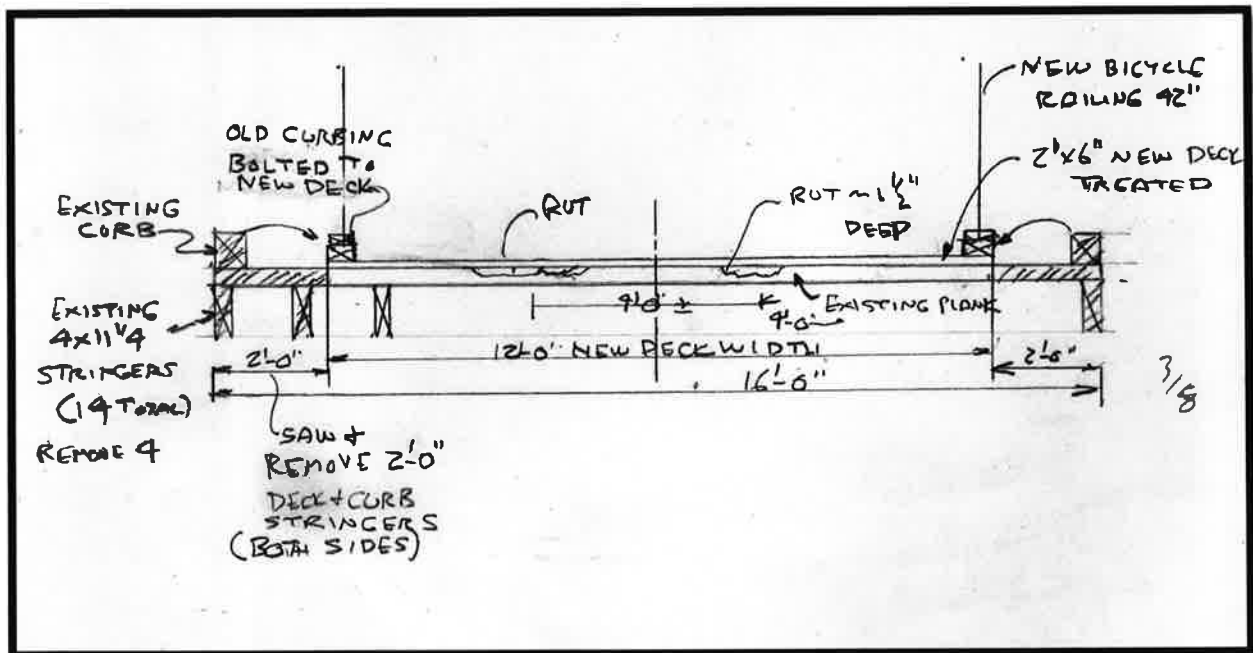

Suggested Deck Structure Based Upon Covering Existing Decking

It will be necessary to modify the existing approaches to fit a new grade and width of deck. Bollards should be placed on the centerline of the approaches to keep vehicles off the bridge. All of this work can be accomplished with town personnel or specialty contractors.

A variation on this proposal would be to remove the existing curb and deck planking completely saving the curbing for reuse. The next steps would be to remove the outer two stringers on each side of the bridge and screwing a new 12' wide deck of treated 2" x 6" boards on the existing stringers. The old curbing would then be placed on the new deck and the railing mounted to the curbing.

Proposal 2

This proposal assumes that the city chooses to replace the entire wooden deck structure and replace it with new treated wood. A recommended sequence of action is as follows,

1. At the lower ends of the northwest, northeast and southeast inclined end posts weld 8" x 32" x 1/4" mild steel plates to span the corroded portions. (I would suggest a 3/32" - 7018 electrode.) On the southwest inclined end post weld an 8" x 32" x 1/2" plate to add bearing area to replace the bearing area on the lower flange of the channels. Weld new under lattice plate at the southeast bridge seat. Remove angle iron on the top chord of the northeast and southeast ends of the trusses.
2. Straighten the channel flange, jack and heat method, and top plate of the inclined post at the southwest corner of the bridge. It may be prudent to support U7 with a crane during this process.
3. Remove soil, etc. around existing cast iron end shoes.
4. Remove chain link fencing and existing railing.

5. Flatten all rust bulges on the top chords and inclined end posts using a method similar to that shown on the YouTube---<https://www.youtube.com/watch?v=k3qC-pXYqqw>.
6. Sand blast ironwork in accordance with blast-cleaned steel (SSPC-SP6). Lead paint exists on the bridge, and all necessary steps must be taken to protect the water in the Fishkill Creek. (After sandblasting the iron work must be inspected for any cracking of the truss members, etc. by the Engineer) (The Department of the Interior does not like sand blasting but in my mind it is the only appropriate way to prepare the bridge for painting.)
7. The ironwork shall be painted with a three-coat system using a zinc-rich primer, an epoxy intermediate, and a polyurethane topcoat such as Tenemec Series 90-97 Tnemec-Zinc, Series 1075 Endura-Shield II, Series 1072 Fluoronar.
8. The color of the bridge to be selected by the City of Beacon. The usual colors were silver, gray, red or black. I personally like gray.
9. Remove existing planking, curbing, etc.
10. Remove wooden stringers.
11. Place new treated wood stringers 4" x 8" at 16" spacing.
12. Screw new decking 2" x 6" planks to stringers.
13. Bolt old curbing to decking.
14. Place standard 42" high bicycle railing.

It will also be necessary to modify the existing approaches to fit a new grade and width of deck. A steel bollard should be placed on the centerline of the approaches to keep vehicles off the bridge. All of this work can be accomplished with town personnel or specialty contractors.

Cost Estimates

The figures given below are estimates of probable cost based upon my experience and some reference to current bidding on similar bridges and are not based upon any competitive bidding by contractors. As I mentioned at our meeting of 5/29/18 much of this work in proposal #1 could be done by highway, or other town, employees.

Proposal 1

Pressure wash entire deck-----	\$500
Remove chain link fencing and old railing-----	\$1,000
Repair work (welding, etc.) to inclined end posts-----	\$4,000
Remove and store existing curbing for later reuse-----	\$2,000
Cut and remove 2' 0" of decking and two stringers each side of bridge -----	\$4,000
Supply and place new 2" x 6" decking 1,248 sf @ \$10/sf-----	\$12,480
Install old curbing and any new curbing-----	\$2,000
Supply and place new bicycle railings 220 lf @ \$100/lf-----	\$22,000
Install bollards at each end of bridge 2 @ \$500-----	\$1,000
Provide 10' wide approaches to each end of bridge, asphalt?-----	<u>\$2,000</u>
Total	\$50,980

No general contractor needed for this work. The city would negotiate with subcontractors directly as required and supervise the work with their own personnel.

Proposal 2

Remove chain link fencing and old railing-----	\$1,000
Repair work (welding, etc.) to inclined end posts-----	\$4,000
Remove all rust bulges on top chord and inclined end posts-----	\$9,600
Remove and store existing curbing for later reuse-----	\$2,000
Remove and dispose of old decking and stringers-----	\$9,600
Sandblast and paint all iron members 10,000sf at \$25/sf-----	\$250,000
Entire new decking 1,296 sf @\$20/sf-----	\$25,920
Install old curbing and any new curbing-----	\$2,000
Supply and place new bicycle railings 220 lf @ \$100/lf-----	\$22,000
Install bollards at each end of bridge 2@ \$500-----	\$1,000
Provide 10' wide approaches to each end of bridge, asphalt?-----	<u>\$2,000</u>
	Total \$329,120

If this was all contracted out General Contractors fees, etc. should be added which could amount to over 20%.

On the painting I did get one estimate from P. S. Buckel, Inc. for \$300 - \$400,000. I think some competitive bidding would get the price down to the \$250,000 I estimated.

In addition to the above the masonry should be pointed where required and the tree close to the masonry at the southeast corner should be removed and the stone block moved back into alignment.

Conclusion

The bridge is in remarkable condition for a bridge approaching its 140th birthday. The iron work, if rehabilitated in the manner recommended, will last for many more years. The two proposals submitted range from a low \$51,000 to a high of around \$330,000.

The work could also be carried out in stages combining the two proposals. The entire work for proposal #1 could be carried out initially with a new deck overlaid on the existing deck and new railings, etc. installed.

The second phase would be the flattening of the rust bulges for \$9,600 followed by sandblasting and painting of the bridge in the amount of \$250,000. With this completed the bridge would be restored to its near original condition and appearance and have a life span of many decades, yes even centuries. It would join other New York Whipple Bridges as the 1860s Union College Bowstring by Shipman & Son, a National Historic Civil Engineering Landmark, the Claverack, Shaw Bridge built by John Hutchinson, The Aldrich Change Bridge in Palmyra by John Hutchinson in 1858, The Boonville Whipple across the Black River Canal (formerly the Talcottville Bridge) and the Vischer's Ferry Whipple Bridge (formerly at Sprakers Basin and later across the Cayadutta Creek in Fonda) by Whipple himself in 1869. All of these were moved and restored at new locations with the exception of the Shaw Bridge which is being rehabilitated in place. The writer has been involved with all of these bridges and has written extensively on Whipple and his works.

The bridge would surely be eligible for listing on the National Register being the last of its kind in its original location and based upon the design of Squire Whipple, the Father of the Iron Truss Bridge. As a bridge it is of greater significance than the former Tioronda Bridge that was on the National Register. It would also, in the mind of the writer, be eligible as a National Historic Civil Engineering Landmark by the American Society of Civil Engineers.

The writer stands ready to assist the City of Beacon in future planning for the restoration of the bridge.